



PACKAGING AND MARKING GUIDELINE

AVL SET GmbH

All rights reserved.

No part of this document may be reproduced in any form nor transmitted by any means of transmission, including the production of copies of any type, the production of recordings and any other type of storage or replaying without the prior express written permission of the company AVL SET GmbH, Franz-Josef-Spiegler-Str. 5, 88239 Wangen im Allgäu/Germany

Contents

1	PURPOSE	4
2	SCOPE OF APPLICATION	4
3	GENERAL INFORMATION	4
4	PACKAGING REQUIREMENT	4
4.1	Stress-compliant packaging	4
4.2	Load bearing capacity	5
4.2.1	Stacking crush pressure.....	5
4.2.2	Load.....	5
4.3	Maximum net weights.....	5
4.4	Ecological principles	5
4.5	Packaging materials	6
4.6	Reach identification.....	6
5	MATERIAL CLASSIFICATION.....	6
6	CARRIAGE CLASS	7
7	PACKAGING EXECUTION	8
7.1	Packaging execution – selection table.....	8
8	PACKAGING CATEGOERIES	8
8.1	Category 1 - Carriage – wooden (covered, shrunken or wound in PE-film).....	8
8.2	Category 2 - Cardboard box.....	9
8.3	Category 3 - Cardboard box on Euro-pallet or non-returnable pallet.....	9
8.4	Category 4 - EURO-Palette	9
8.5	Category 5 - Non-returnable wooden pallet	9
8.6	Category 6 - Box normal/seaworthy up to 2,500 kg.....	9
8.7	Category 7 – Seaworthy box - wooden.....	10
8.8	Category 8 - Normal box - board design	12
8.9	Category 9 - Normal box – board design (without solid wood use)	12
8.10	Category 10 - Seaworthy box - board design.....	12
8.11	Category 11 - Seaworthy box - board design with corrosion protection	14
8.12	Category 12 - Seaworthy box with corrosion protection	14
9	CORROSION PROTECTION.....	14
9.1	Protective layer method	14
9.1.1	Corrosion protection using coating material	14

PACKAGING AND MARKING GUIDELINE

9.1.2	Corrosion protecting using agents based on mineral oil	14
9.2	Drying agent method	14
9.3	VCI-Film (Volatile Corrosion Inhibitor)	16
10	PACKAGING DESIGN.....	16
10.1	Joining of box party.....	16
10.1.1	Nailing.....	16
10.1.2	Screw connection.....	16
10.2	Interior protection	17
10.3	Protection from climatic and moisture influences	18
10.4	Heavy cargo fittings.....	18
11	CTU-CODE (CTU = CARGO TRANSPORT UNIT)	19
12	DISPATCH GUIDELINES	23
12.1	Product packaging (inner packaging) and labelling.....	23
12.2	Transport packaging (outer packaging).....	23
12.2.1	Leading mark	23
12.2.2	Information marking	24
12.2.3	Handling mark.....	24
12.2.4	Delivery note specifications.....	25
12.2.5	Material sets.....	25
12.2.6	Packing lists.....	25
12.2.7	Hazardous goods.....	25
13	INDICATORS.....	26
13.1	Tilt indicator	26
13.2	Impact indicators	27
14	IPPC/ ISPM NO. 15.....	29
14.1	IPPC-STANDARD (International Plant Protection Convention)	29
14.1.1	IPPC marking.....	29
15	COST ASSUMPTION	29
16	TRANSPORT DAMAGES.....	30
17	GOODS ACCEPTANCE TIMES	30
18	ANNEX	31
19	APPLICABLE DOCUMENTS	33

1 Purpose

This regulation contains all requirements concerning the packaging and the delivery of goods to and from AVL Groups.

2 Scope of Application

The regulation is valid for every delivery of goods which is supplied to and from locations of AVL Groups. The following instructions are an additional contractual agreement to the purchase orders which are submitted by AVL buyers. Deliveries of goods will be standardly checked at the goods receipt regarding the compliance with these requirements. Any deviation from the regulations set out below will be part of the supplier evaluation system of AVL.

3 General information

This regulation defines the minimum packaging requirements. It does not release the supplier or packer in any way from its warranty and/or responsibility for quality-compliant packaging. If it is identifiable from the expertise or experience of the contractor that additional measures are required for protecting the goods, then the contractor must take the corresponding measures.

The objective of the packaging guideline is to protect all the goods from the various loads (e.g. pressure, shock, fall, vibration or temperature influences) in the course of the logistics chain so that the goods can be provided for use at the target location in sound condition.

DIN1052 (Design of timber structures) is applicable to the calculation and design of all the wooden packaging.

The contractor is under an obligation to carefully check all the packaging regulations provided to it, immediately upon receipt, taking into consideration the goods to be conveyed, transport route, destination and storage requirements and immediately notify us of any possible defects, shortcomings, incompletions or faults.

4 Packaging requirement

Owing to the transport stresses, a stress-compliant packaging is necessary, which protects the packaged good adequately during the entire transport route.

4.1 Stress-compliant packaging

The execution of stress-compliant packaging, corrosion protection and marking depends on the following aspects among other things:

- Country of destination (quality of the transport routes)
- Transport routes (turnover rate, etc.)
- Transport type (railway/truck/ship/aircraft, etc.)
- Transport and storage duration
- Storage type (covered)
- Storage duration (minimum 12 months)
- Temperature (-25°C to +60°C)
- Humidity as well as
- physical quality of the goods (e.g. weight, sensitivity, etc.)

In principle, the size of the packages must be optimally adapted to the packaged good, especially with respect to space-saving and freight-saving packaging, and also a risk-free transportation and smooth assembly. The aspect of exceeding the loading gauge must also be considered in this case.

The packaging must be designed such that damage is neither caused to the packaged good nor to the packaging due to tilting, shifting, swinging, swaying, lifting, etc. under normal conditions.

The outer packaging must be provided such that the packaged good can be moved using lifting tools and/or floor-level conveyors.

The packaging must be essentially designed such that the packaged good and the packaging withstand a free fall from a height of 40 cm unscathed. Furthermore, the packaging must comply with the latest environmental regulations. The packaging wood used must fulfil the phytosanitary requirements in accordance with ISPM Standard No. 15 and must be marked accordingly.

4.2 Load bearing capacity

4.2.1 Stacking crush pressure

The frame structure of crates, boxes, etc. must be designed such that it withstands a stacking crush pressure of 10 kN/m² (1 t/m²) unscathed.

4.2.2 Load

The packaged goods must be secured within their packaging against horizontally influencing forces (tilting, shunting impact, impacts, etc.), which can occur during the transportation, such that in case of loads as per Figure 25 (examples of acceleration forces during transport operations) there are no damages either to the packaged good or to the packaging.

4.3 Maximum net weights

Packets	≤ 30 kg
Cardboard pallets	≤ 500 kg
Cardboard pallets in case of air freights	≤ 150 kg; > 150 kg Kisten
Lattice boxes	≤ 1000 kg
Euro pallet	≤ 1000 kg

4.4 Ecological principles

Restriction to the packaging size required in terms of the weight and volume. If the package content allows it, the following dimensions must be adhered to imperatively. (Conserving the resources and reducing the transport volumes).

Truck: max. box size L × W × H: xxx × 240 × 250 cm (storage space width and height - tarpaulin lorry)

Sea freight / container: max. box size L × W × H: xxx × 230 × 250 cm (storage space width and height - box container)

Air freight: max. box size L × W × H: xxx × xxx × 160 cm (storage space height - air freight)

4.5 Packaging materials

Material	approved Material	not approved Material
Non-returnable packaging	PE, PP	
Reusable packaging	PE	
Shrink and stretch film	PE	
expanded polystyrene (Styrofoam)		not approved
Packaging chips		not approved
Paper and cardboard boxes	free from harmful substances; VCI papers, for which material recycling is jointly possible demonstrably (protective paper with paper/cardboard)	
Wood	Plywood, laminated wood or treated wood as per IPPC standards	

AVL – Box	Plywood
	5x glue-laminated
	EN 636-3
Emission class	E1
Material	Spruce plywood
Glue class	3 (BC 3)
Bulk density	499 kg/m ³
Utilisation classes	
1... Dry area	3
2... Humid area	Outer area
3... Outer area	Climatic conditions, which lead to higher material moisture than utilisation class 2
Bending strength	30 bis 60 N/mm ²

4.6 Reach identification

All the materials must be labelled in accordance with the directive.

5 Material classification

As the parts to be packed have different sensitivity physically and chemically, they are classified in the following goods classes depending on their quality.

MK 1

Impact and corrosion-resistant, heavy, bulky and robust products:
Steel constructions, profile bars, scaffolds, sheets, etc.

MK 2

Parts which require physical protection:
Structural elements which cannot be classified in class 1, steel constructions and supporting structures, thin-walled sheet metal parts, guard rails, smaller pipes, etc.

MK 3

Corrosion-resistant parts that require physical protection:
Construction parts and fastening elements (such as flanges, brackets for screws, springs, bolts, etc.).

MK 4

Corrosion-sensitive parts, which require physical and chemical protection:
General mechanical parts (such as axles, drives, valves, products with machining areas, gears, shafts), replacement parts, non-rust-free fastening elements, etc.

MK 5

Parts that are corrosion-sensitive and/or extraordinarily impact-/ vibration-sensitive:
Electronic and precision measuring devices, position regulators, switch panels, control cabinets, limit switches, pressure gauges, position detectors, etc.

MK 6

Hazardous goods:
Batteries, adhesives, colours, chemicals, acids, solvents, sprays, etc.

6 Carriage class

Class 1: TRUCK

This class comprises all the truck transportation options by land, such as house-house transportation, consolidated transportation with or without multiple trans-shipment.

Class 2: RAILWAY

This class is defined by the rail transport type: - Car load

Class 3: SEA

Class 4: CONTAINER

When transporting with the seagoing vessel, a distinction is essentially made with respect to the packaging, loading in a conventional manner and loading in the container.

The difference in the packaging is that when loading in a container, the boxes and crates, as per goods class, need not be designed for a dynamic pressure of 1 t/m².

When selecting the packaging category in the relevant goods class, ensure that a container is not considered as packaging, but as a means of conveyance.

Class 5: AIR

Transports which are carried out by using aircrafts as modes of transport. The dead weight of the packaging should not be very high in this case, but it must be adapted to the goods class or be suitable for multiple trans-shipment.

7 Packaging execution

If multiple modes of transport are to be used for dispatching the goods, packaging must then be done in accordance with the highest packaging category/carriage class.

7.1 Packaging execution – selection table

Carriage class	1 TRUCK	2 RAIL- WAY	3 SEA	4 CONTAINER	5 AIR
Material classification	PACKAGING CATEGORY				
MK 1	1, 5	1, 5	1, 5	1, 5	1, 6 8, 9
MK 2	1, 4, 5, 6	1, 4, 5, 6	7, 10	1, 4, 5, 6	1, 4 5, 6, 8
MK 3	2, 3 6, 8, 9	6, 8, 9	6, 7, 10	6, 7, 10	2, 3 6, 8, 9
MK 4	3, 6, 8, 9	6, 8, 9	6, 11 12	6, 7, 10 11, 12	2, 3 6, 8, 9
MK 5	2, 3 6, 8, 9	6, 8, 9	6, 11, 12	6, 11, 12	2, 3, 6, 8 9, 11, 12
MK 6	ADR	RID	IMDG- Code	IMDG- Code	IATA

8 Packaging categories

8.1 Category 1 - Carriage – wooden (covered, shrunken or wound in PE-film)

Kick plates screwed together with the package, which allow a manipulation with the forklift. The lumbers for the kick plates must have a minimum thickness of 5 cm. The packaging good is packed by means of shrinking in the PE-film.

8.2 Category 2 - Cardboard box

Cardboard box (box) for packaging goods up to max. 30 kg and max. EURO pallet size. Design and execution: Folded box as per DIN 55429, made of corrugated board in accordance with DIN 55468, 3-wall, wet strength glued, type 2.96.

8.3 Category 3 - Cardboard box on Euro-pallet or non-returnable pallet

Cardboard box (box) for packaging goods up to max. 500 kg and max. EURO pallet size. (Air freight max. 150 kg)

The cardboard boxes are fastened with a zinc-anodised steel strip or non-metallic strap. The cardboard boxes must be correspondingly protected from damage using the fasteners.

8.4 Category 4 - EURO-Palette

Four-way flat pallet made of wood 800 x 1200 mm (European pool pallet) as per EN 13698-1. The parts are fastened with a zinc-anodised steel strip or non-metallic strap. The parts must be correspondingly protected from damage using the fasteners

8.5 Category 5 - Non-returnable wooden pallet

Use for packaging goods of different types from approx. 500 kg to approx. 4000 kg and lengths up to approx. 6 m. The parts are fastened with a zinc-anodised steel strip or non-metallic strap. The parts must be correspondingly protected from damage using the fasteners. The pallet is intended only for one-time use.

Execution: Horizontal timbers that are min. 25 to 50 mm thick depending on the weight, lined externally with 30 mm planks. Kick plate min. 8 x 10 cm square timber.

8.6 Category 6 - Box normal/seaworthy up to 2,500 kg

Floor: Execution with ground skids or scales, bottom formwork min. 12 mm strong; floor space from 1.5 m² onwards and if the width and/or length is > 50 cm, bottom formwork min. 24 mm strong. **Side wall:** Board thickness min. 12 mm, strap frame 12 - 24 mm strong, up to max. height and width of 120 cm inside. Board stacks inside provided with a strap, same strength as strap frames.

End wall: Execution like side wall.

Cover: Multilayer boards min. 12 mm, board stacks inside provided with a strap, area from 1.5m² onwards and if the width and/or length is > 50 cm, cover design min. 24 mm strong. Cover design only 12 mm for a box height of 180 cm and onwards. Box must not be over stacked at all! Lettering as per annexe – handling mark no. 14.

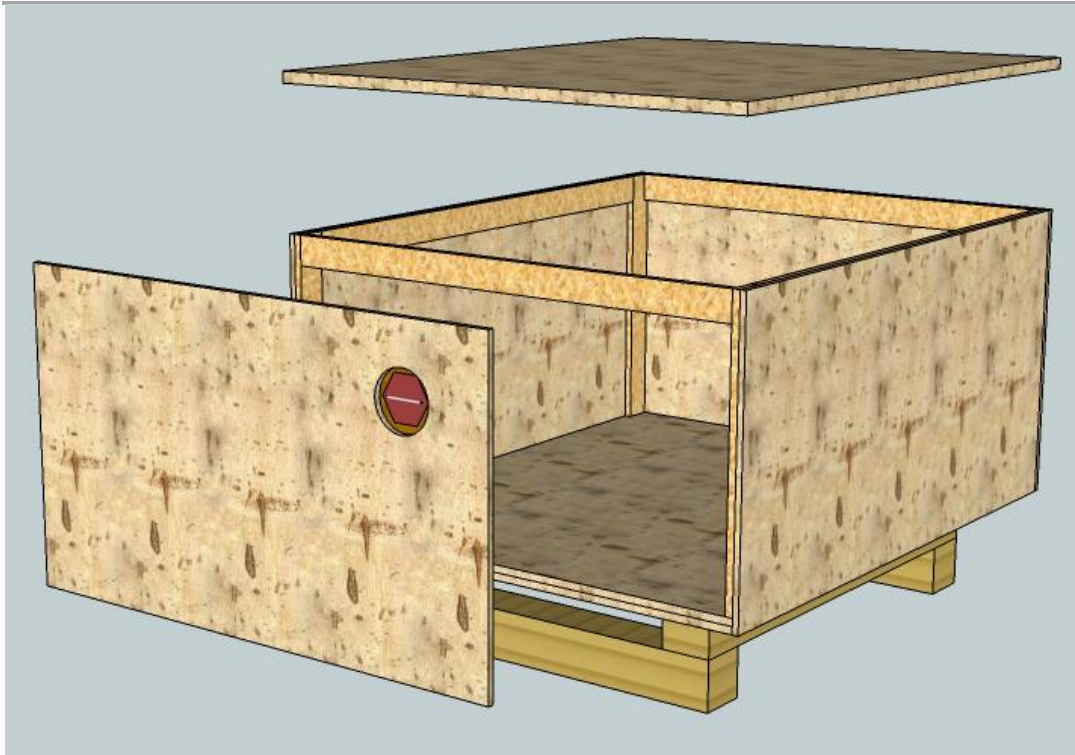

Figure 1: Board box AVL-execution

8.7 Category 7 – Seaworthy box - wooden

Floor: Skids (carriage) longitudinal, bottom formwork min. 30 mm strong, blocked nailed up to max. 5 mm, end wall square timber with longitudinal skid (carriage) bolted (through screws with washer and nut).

Kick plates (crosswise-skids) ≤ 3000 kg 10 x 8 cm, > 3000 kg 12 x 10 cm strength, distance max. 120 cm, must be bolted to the longitudinal or intermediate skids or nailed several times. (Mounting depending on the position of center of gravity, interrupted for the forklift intervention and suitable for rope stops).

Mass	Strength/cross-section	Mass	Strength/cross-section
≤ 1000 kg	50 mm	≤ 10000 kg	12 x 16 cm
≤ 2500 kg	8 x 10 cm	> 10000 kg	16 x 20 cm
≤ 5000 kg	10 x 12 cm		

heavy cargo fittings must be attached after 5 t.

Table1: Longitudinal-lower skid strength (carriage)

Side wall: Formwork vertical or transverse, min. 24 mm strong, strap frames and diagonals inside. Up to 120 cm width and height with one diagonal 30 to 45°. A coating with waterproof speciality paper must be fitted such that it adequately overlaps between the strap frame and formwork.

Dunnage distance max. 70 cm and lined, min. 40 mm strong and 80 mm wide.

End wall: Formwork vertical or transverse, min. 24 mm strong, strap frames and diagonals inside, up to 120 cm wide and height with one diagonal (30 to 45°), coating like side wall.

Cover: Formwork longitudinal or transverse, min. 24 mm strong, with strap frames, with 6 mm plywood board, covered with PE-film in between. The cover strap frames must be rest on the strap frames of the end and side walls.

PACKAGING AND MARKING GUIDELINE

Strap frames, diagonals and cover compression woods must be designed for a stacking dynamic pressure of minimum 1.0 t/m².

Box width inside	Strength/ cross-section	Box width inside	Strength/ cross-section
≤ 100 cm	50 mm	≤ 300 cm	12 x 16 cm horizontal
≤ 150 cm	8 x 10 cm	> 300 cm	12 x 16 cm vertical
≤ 200 cm	10 x 12 cm		

Table2: Cover compression woods

The cover compression woods including the dunnages (cover compression wood supports) must be inserted at intervals of max. 70 cm and nailed with the cover or the side walls.

Strapping: The box must be strapped with at least 2 non-metallic straps (min. 19 mm wide) at intervals of max. 2 m.

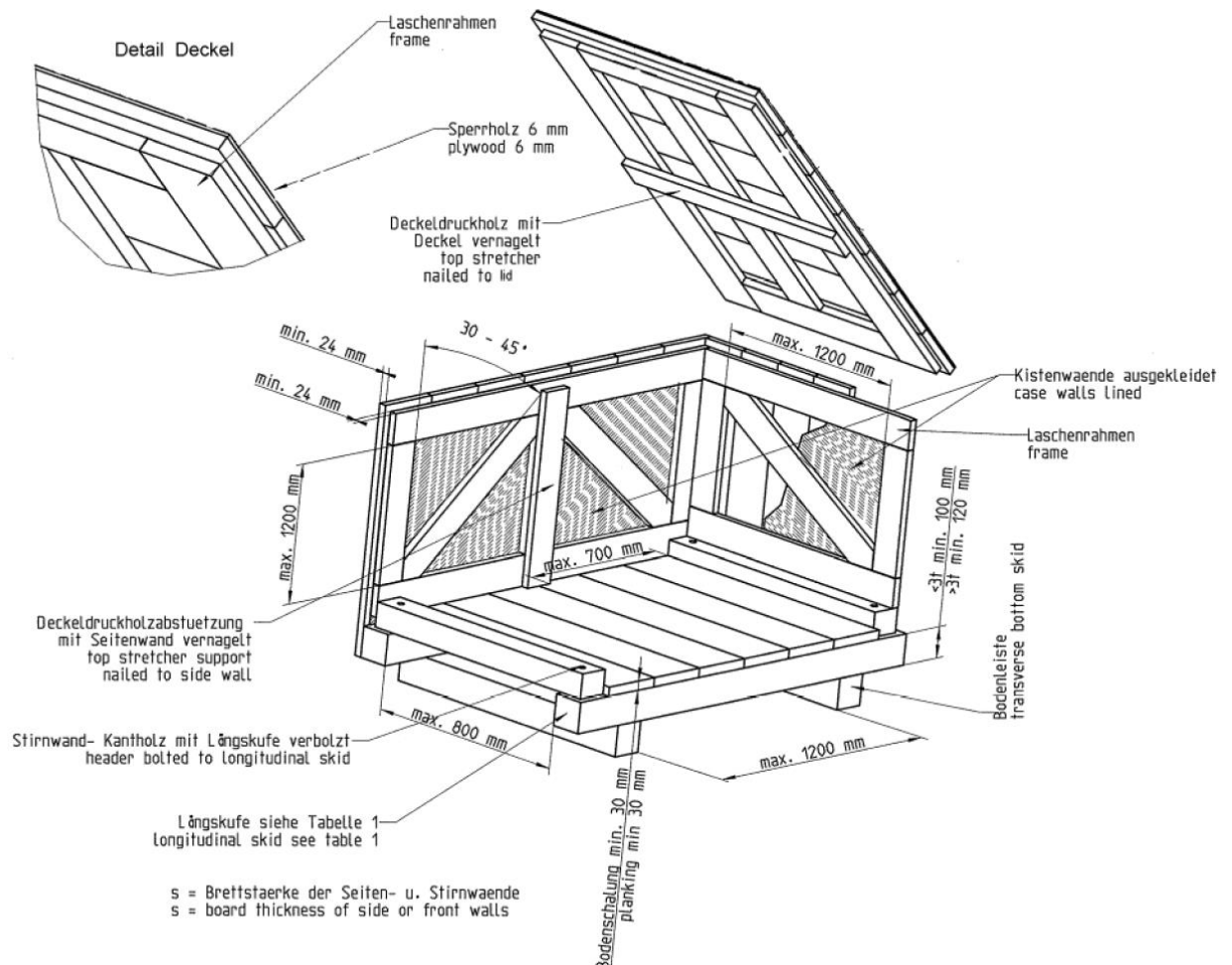

Figure 2: seaworthy - wooden

PACKAGING AND MARKING GUIDELINE

8.8 Category 8 - Normal box - board design

a) Use \leq 500 kg

Floor: Board min. 12 mm nailed with kick plates (crosswise-skids) 10 x 5 cm.

Side + end walls: Board min. 12 mm nailed together bluntly.

Cover: Board min. 12 mm.

b) Use $>$ 500 kg

Floor: Board min. 12 mm nailed with longitudinal-lower skids (carriage).

Box walls and cover: with min. 15 mm strap frame.

Above 800 kg, 24 mm strap frame.

Mass	Strength/cross-section	Mass	Strength/cross-section
\leq 1000 kg	50 mm	\leq 10000 kg	12 x 16 cm
\leq 2500 kg	8 x 10 cm	$>$ 10000 kg	16 x 20 cm
\leq 5000 kg	10 x 12 cm		

heavy cargo fittings must be attached after 5 t.

Table3: Longitudinal-lower skid strength (carriage)



Figure 3: Box up to 500 kg and box above 500 kg

8.9 Category 9 - Normal box – board design (without solid wood use)

Just like category 8, but strap frames, bracing and lower skids are designed exclusively in the board material.

8.10 Category 10 - Seaworthy box - board design

Floor: Skids longitudinal (carriage), bottom formwork min. 15 mm strong when using boards and min. 24 mm strong when using planks. End wall square timber with longitudinal skid (carriage) bolted (through screws with washers and nuts). Kick plates (crosswise-skids), distance max. 120 cm, must be bolted with the longitudinal or intermediate skids or nailed

PACKAGING AND MARKING GUIDELINE

several times (Mounting depending on the position of centre of gravity, interrupted for the forklift intervention and suitable for rope stops).

Mass	Strength/cross-section	Mass	Strength/cross-section
≤ 1000 kg	50 mm	≤ 10000 kg	12 x 16 cm
≤ 2500 kg	8 x 10 cm	> 10000 kg	16 x 20 cm
≤ 5000 kg	10 x 12 cm		

heavy cargo fittings must be attached after 5 t.

Table4: Longitudinal-lower skid strength (carriage)

Side wall: Board thickness min. 12 mm, strap frame min. 24 mm strong, up to max. height and width of 120 cm inside. Board stacks inside provided with a strap, same strength as strap frames. Dunnage distance max. 70 cm and lined, min. 40 mm strong and 80 mm wide.

End wall: Execution like side wall.

Cover: Plywood or OSB/3 boards with min. 12 mm, board stacks inside provided with a strap, same strength as strap frames min. 24 mm. The cover compression woods including dunnages (cover compression wood supports) must be inserted at intervals of max. 70 cm and nailed with the cover or the side walls.

Strap frames, diagonals and cover compression woods must be designed for a stacking dynamic pressure of minimum 1.0 t/m².

Box inside width	Strength/cross-section	Box inside width	Strength/cross-section
≤ 100 cm	50 mm	≤ 300 cm	12 x 16 cm horizontal

Strapping: The box must be strapped with at least 2 non-metallic straps (min. 19 mm wide) at intervals of max. 2 m.

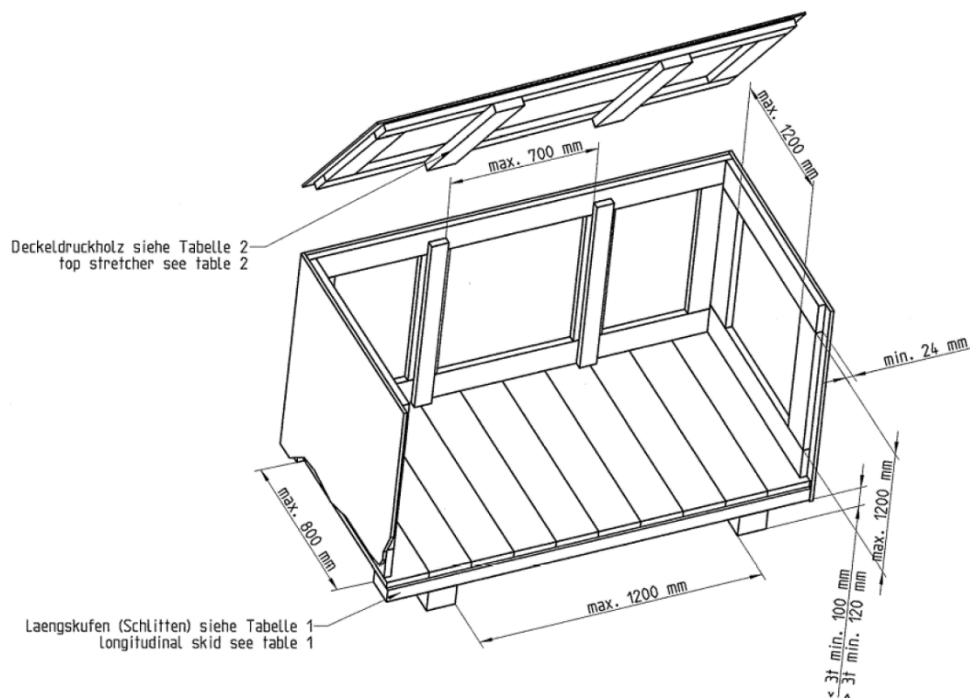

Figure 4: Box – seaworthy – board design

8.11 Category 11 - Seaworthy box - board design with corrosion protection

Just like category 10. The goods must be welded in an aluminium laminated film or VCI-film. Edges or protruding parts must be adequately cushioned. Distance between film and box wall 3 to 5 cm.

The direct contact of the film with the box floor must be avoided (insertion of bubble wrap, foam material, etc.). Sealing of the bolting as per Figure 7.

8.12 Category 12 - Seaworthy box with corrosion protection

Box and cover design as per category 7 or 10.

The goods must be welded in an aluminium laminated film or VCI-film. Edges or protruding parts must be adequately cushioned. Distance between film and box wall 3 to 5 cm.

The direct contact of the film with the box floor must be avoided (insertion of bubble wrap, foam material, etc.).

9 Corrosion protection

9.1 Protective layer method

9.1.1 Corrosion protection using coating material

Products, which are protected using coating material against corrosion, must be correspondingly pre-treated for safe adhesion of the coating material. The metal surface must be clean, dry and corrosion-free

Hence, the pre-treatment i.e. a careful cleaning and drying of the surface, and the subsequent application of the protective layer must always take place together.

9.1.2 Corrosion protecting using agents based on mineral oil

Surfaces, which are not protected against corrosion using coating material, must be treated with agents based on mineral oil (PERIGOL[®] VCI 230, Helamin, Tectyl 506, corrosion protection greases or oils).

9.2 Drying agent method

A flexible barrier layer cover for a conservation duration of minimum 12 months must be specified for the intended transport and storage duration.

The barrier layers used in the process are:

- Polyethylene film (PE)
LD polyethylene min. 0.2 mm thickness as per DIN 55530
The use of PE-films for film covers with a thickness less than 0.2 mm is permissible if the techn. requirements of DIN 55530 for a 0.2 mm thick film are fulfilled.
- Aluminium laminated film as per DIN 55531 / TL8135-0003

PACKAGING AND MARKING GUIDELINE

The humidity must not exceed the value of 40% across the entire period of the transport, transshipment and storage.

The materials must be welded in the film, and the air from the film bag must be exhausted before welding the last opening to the extent that a wear through of the cover due to the transport loads will be avoided.

For absorbing the humidity, adequate quantity of drying agents as per DIN 55473 (TL 6850008) must be added. In order to avoid contact corrosion, the drying agents must be applied such that direct contact with the packed good is not possible.

The quantity of the drying agent is specified in accordance with DIN 55474 with:

Faktor	Bedeutung	Rechenwert				
n	Anzahl der Trockenmittel					
a	je Trockenmitteleinheit aufnehmbare Wassermenge entsprechend der zulässigen maximalen Luftfeuchte in der Packung „zulässige Endfeuchte“ in %	Zul. Endfeuchte	20 %	40 %	50 %	60 %
		Faktor a	3	6	7	8
e	Korrekturfaktor bezogen auf die zul. Endfeuchte	Faktor e	0,9	0,7	0,65	0,6
v	Innenvolumen der Packung in m ³					
b	Feuchtegehalt der eingeschlossenen Luft in g/m ³	Z. B. bei 20 °C und 85 % rel. Feuchte b = 15 g/m ³				
m	Masse der hygroskopischen Packhilfsmittel in kg					
c	Faktor für den Feuchtegehalt der hygroskopischen Packhilfsmittel in g/kg [0/00]	<ul style="list-style-type: none"> 80 für Holz, lufttrocken = 18 % Wassergehalt 				
		<ul style="list-style-type: none"> 80 für Holz und Pappe 80 für Polstermittel auf organischer Basis 				
A	Oberfläche der Sperrschichthülle in m ²					
WDD	Wasserdampfdurchlässigkeit der Sperrschichthülle für das zu erwartende Klima in g/m ² * d gemessen nach DIN 53 122-1 oder DIN EN ISO 15 106-3	Beispielwerte geeigneter Folien:				
		Art der Folie	Prüfklima			
			20/85	38/90		
		LD-Pe 0,2 mm dick	0,4	2,0		
Al-Verbund	< 0,1	0,1				
Es sollte mindestens der Wert 0,1 g/m ² * d in die Formel eingesetzt werden.						
t	gesamte Transport- und Lagerzeit in Tagen					

Table 5: Notation for calculating the number of drying agent units

$$n = \frac{1}{a} (V * b + m * c + A * e * WDD * t)$$

9.3 VCI-Film (Volatile Corrosion Inhibitor)

A VCI film with a minimum strength of 120-150 µm for a conservation duration of minimum 12 months must be specified for the intended transport and storage duration.

The materials must be welded in the VCI-film. A wear through of the film due to transport loads must be avoided. A leakage test must be conducted after processing the film. For optimum effectiveness of the VCI method, the metallic surface of the packaged good must be clean (i.e. dry, not oily and/or corrosive, as well as free from any residues). The distance of the VCI dispenser to the metallic surface must not exceed 30 cm. In case of large internal volume, additional VCI dispensers must be attached.

The VCI materials used must be free from nitrites, heavy metals, halogens, silicones and other substances subject to marking.

As recommended, VCI products of Zerust Excor®.

Contact persons worldwide: <http://www.excor.de/kontakt/weltkarte.html>

10 Packaging design

10.1 Joining of box party

The cover and a side part (long side) must be generally screwed in every design so that the removal of goods is facilitated.

Transport boxes used repeatedly must be screwed together 100%. (e.g. unpacking for tests or quality checks, etc.)

In case of raw board materials such as plywood, OSB, raw clamping plates, etc., no screw nails must be used.

10.1.1 Nailing

The nails must not protrude from the wooden surface. The nail heads must not countersunk more than 2 mm and must cut flush with the wooden surface.

10.1.2 Screw connection

Screws must not protrude from the wooden surface. The screw-in depth must be at least 4 x d. Adhere to screws with d ≤ 8 mm specification for nails. Only countersunk screws may be used.

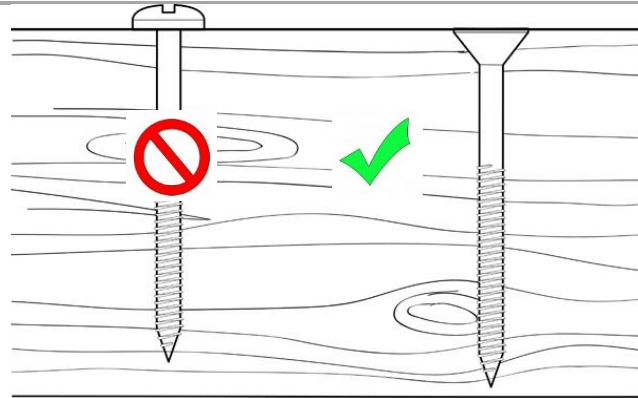

Figure : Screw connection of the box party

10.2 Interior protection

If the base of the packaged good is less than its maximum dimensions in length/width, suitable supports must be mounted. Supports made of neoprene, polyfoam or cardboard must be used for the supporting surfaces. The parts must be correspondingly protected from damage using the fasteners. For protecting the workpiece surface, intermediate layers made of foam (polystyrene, polyurethane or polyethylene) must be used.

The packaged good must be essentially fastened to the box or crate or the box floor such that it is immovable. This is done with the help of through screw connections – also through the skids or filling material between packaged goods and cardboard or crate wall. If sensitive goods are jarred, an insulation between goods and floor must be installed. If the packaged good cannot be fastened to the floor in this manner, sufficient transit support must be ensured with the help of square timber struts.

Penetrations in the film bags, e.g. for fastening the packaged good to the box floor, must be sealed in an airtight manner externally using intermediate layers of rubber plates.

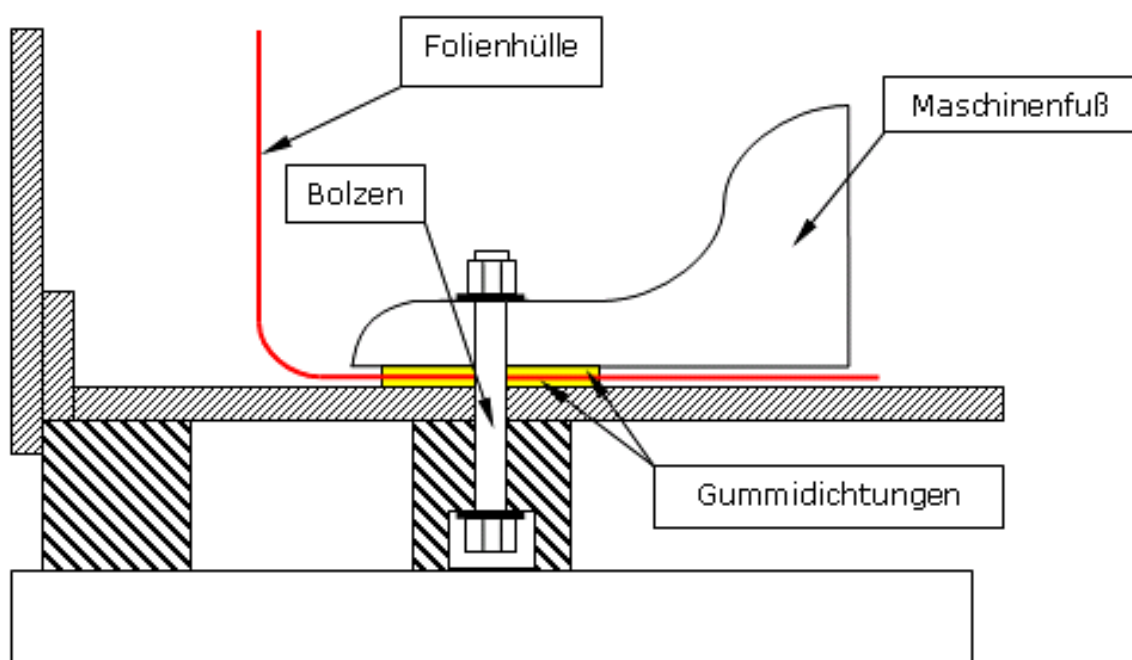

PACKAGING AND MARKING GUIDELINE

Figure 5: Bolting between packaged good and box floor with inserted seal, an insulation between goods and floor / wall

Sharp edges, corners, protruding screws, pipe sockets, electrical connection boxes, display windows, LCD displays, control boxes, keyboard, glass surfaces, pressure gauges and the like must be covered with the help of foam cushions or bubble wrap. Only anti-hygroscopic filling and padding material is used. Cardboard boxes, wood wool, unwaxed paper, etc. must not be used under any circumstances.

10.3 Protection from climatic and moisture influences

A plastic plate (Akylux) or hardboard with separating foil must be attached against the lower side of the cover. Stacks must be covered with strips that are 12 cm wide.

Box walls made of timber formwork must line with a barrier layer made of "union paper" to cover the gaps between the individual planks.



Figure 6: Side wall lined with a barrier layer

10.4 Heavy cargo fittings

Boxes with a gross weight of more than 5 t are fitted with steel fittings at the top and bottom edges in the rope layer (sheet thickness depending on the weight, but minimum 3 mm).

Gross weight of package [t]	Steel sheet thickness [mm]
> 5 bis 10	3,0
> 10 bis 25	6,0
> 25 bis 50	8,0
> 50	10,0

Table6: Steel sheet thickness of the heavy cargo fittings

The upper fittings must be min. 70 cm long after a box length of 250 cm.

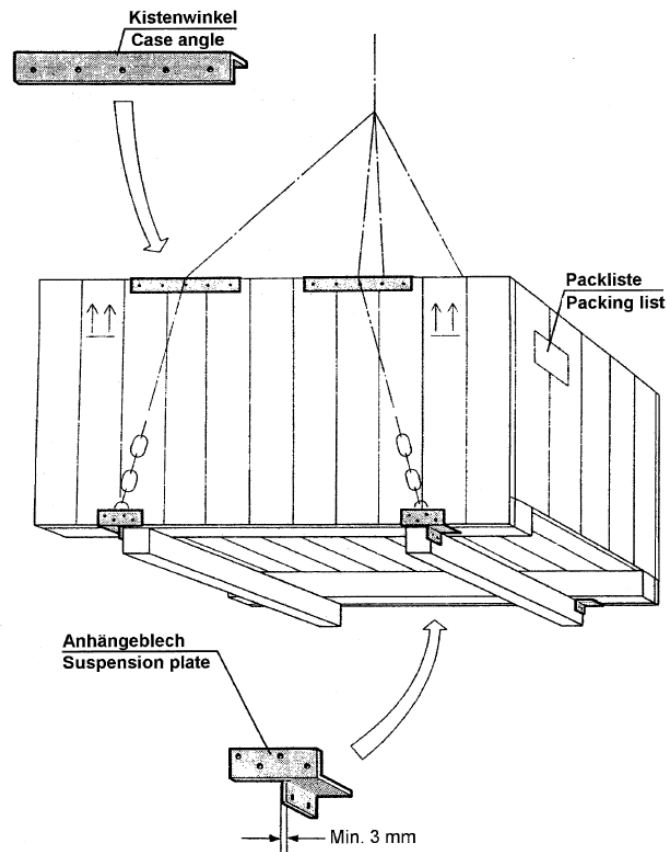

Figure 7: Representation using the arrangement of the heavy cargo fittings

11 CTU-Code (CTU = Cargo Transport Unit)

As a result of the TUL process (Transport, Trans-shipment, Storage), the varied acceleration forces have an effect on the packaged good. In accordance with the CTU guideline, they must be considered during the box construction and naturally also when mounting the packaged good within the box. In order to prevent the load from moving, the load must be secured starting from the most unfavourable combination of horizontal and correspondingly vertical acceleration forces in the longitudinal and transverse direction.

The acceleration to be adhered to during the conveyance is the gravitational acceleration $g = 9.81 \text{ m/s}^2$

On-road conveyance				
Safeguarding in	acceleration coefficients			
	Longitudinal (c_x)		Transverse (c_y)	Minimum as per below (c_z)
	voraus	zurück		
Longitudinal direction	0,8	0,5	-	1,0
Transverse direction	-	-	0,5	1,0

Source: CTU-Code

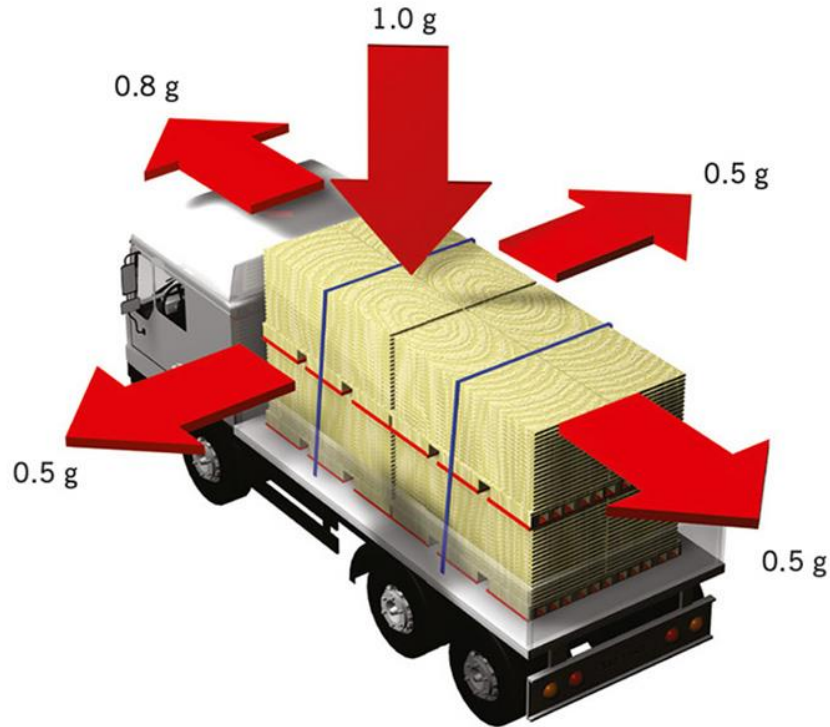

Rail conveyance (Combined traffic – KLV)				
Safeguarding in	acceleration coefficients			
	Longitudinal (c _x)		Transverse (c _y)	Minimum as per below (c _z)
	In advance	back		
Longitudinal direction	0,5 (1,0)*KLV	0,5 (1,0)*KLV	-	1,0 (0,7)*
	0,5 (4,0)*	0,5 (4,0)*		
Transverse direction	-	-	0,5	1,0 (0,7)*

* The values in brackets are applicable to impact loads with only short impacts of 150 milliseconds or shorter and can e.g. be used for designing the packages.

Source: CTU-Code

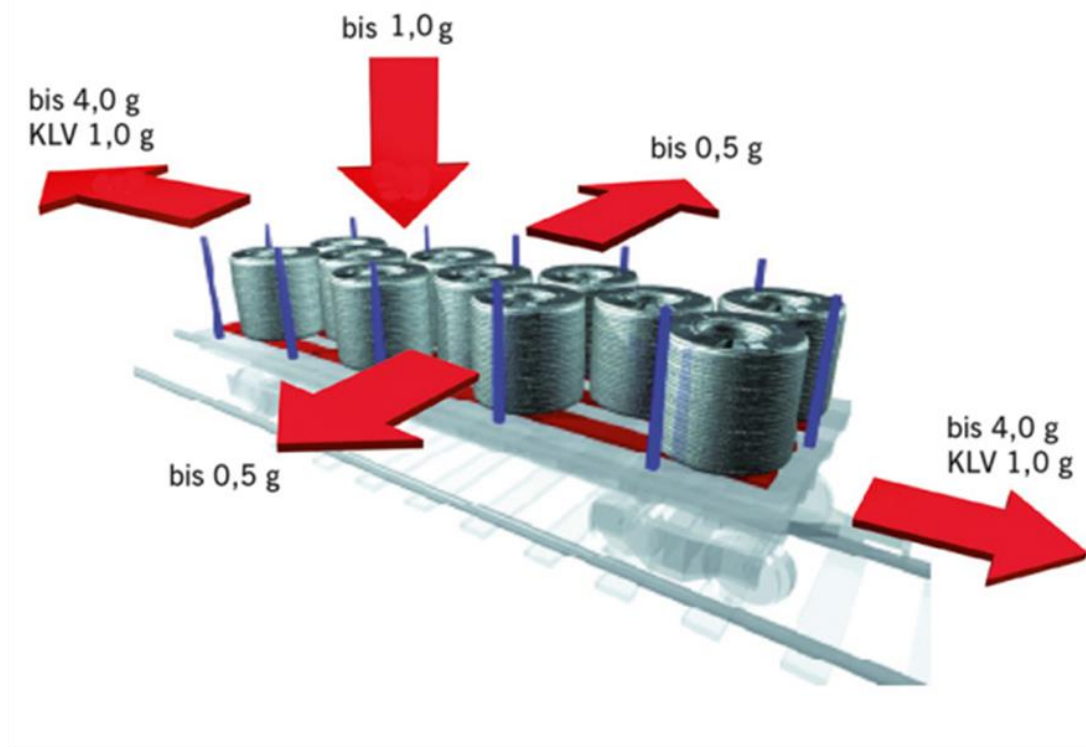

Sea conveyance					
Significant wave height in the sea area		Safeguarding in	acceleration coefficients		
			Längs (c _x)	Longitudinal (c _x)	Minimum as per below (c _z)
A	H _s ≤ 8 m	Longitudinal direction	0,3	-	0,5
		Transverse direction	-	0,5	1,0
B	8 m < H _s ≤ 12 m	Longitudinal direction	0,3	-	0,3
		Transverse direction	-	0,7	1,0
C	H _s > 12 m	Longitudinal direction	0,4	-	0,2
		Transverse direction	-	0,8	1,0

Source: CTU-Code

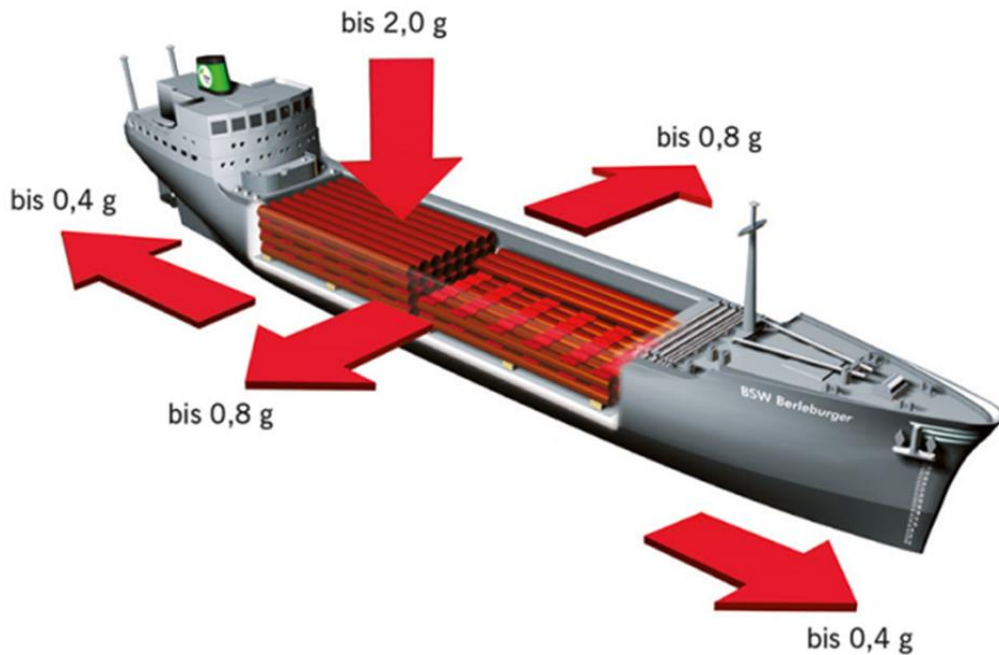

The significant wave height (H_s) is the average formed from the highest one-third of waves (measured from the wave trough to the wave crest). The allocation of geographical sea areas to the corresponding significant wave heights must be taken from the following table:

A	B	C
$H_s \leq 8 \text{ m}$	$8 \text{ m} < H_s \leq 12 \text{ m}$	$H_s > 12 \text{ m}$
Baltic Sea (with Kattegat) Mediterranean Sea Black Sea Red Sea Persian Gulf Coastal journeys or journeys between islands in the following sea areas: Central Atlantic (30°N to 35°S) Central Indian Ocean (up to 35°S) Central Pacific (30°N to 35°S)	North Sea Skagerrak Strait The English Channel Sea of Japan Sea of Okhotsk Coastal journeys or journeys between islands in the following sea areas: Südzentraler Atlantik (35°S bis 40°S) South-central Atlantic (35°S to 40°S) South-central Indian Ocean (35°S to 40°S) South-central Pacific (35°S to 45°S)	unlimited

Source: CTU-Code

Figure 8: Examples of acceleration forces during transport operations

12 Dispatch guidelines

The following identification marks must be adhered to when dispatching goods.

12.1 Product packaging (inner packaging) and labelling

Every product must be labelled and packed as follows:

1. One packaging unit depending on the order item
2. Material number of the supplier
3. AVL material number (if available)
4. Quantity and unit of quantity
5. AVL order number and order item
6. Series number in text and barcode (EAN type 128) (if available)
7. Batch number in text and barcode (EAN type 128) (if available)

Exception: Grid packaging for PCBs (printed circuit boards)

Lieferanten Materialnummer: 123456	AVL - Materialnummer: XY1234
Bestellnummer: 3110022	Bestellposition: 0010
Menge: 1200	Mengeneinheit: Stück
Seriennummer: 987654321 	Chargennummer: 2468 

Figure 9: Example of barcode and text arrangement for product packaging

12.2 Transport packaging (outer packaging)

12.2.1 Leading mark

- Identification mark: AVL logo and name (only for indigenous production)
- Identification number: AVL production and serial number
- Customer and order number

PACKAGING AND MARKING GUIDELINE

- Customer / item number

12.2.2 Information marking

- Weight details (net and gross)
- Dimensions: L x W x H; the dimensions are specified in cm

12.2.3 Handling mark

Be sure to pay attention to handling markings and use them accordingly.

- whether the package is e.g. sensitive to moisture, cold or temperature
- storage under roof
- where the position of centre of gravity is
- where belts and the like may be affected

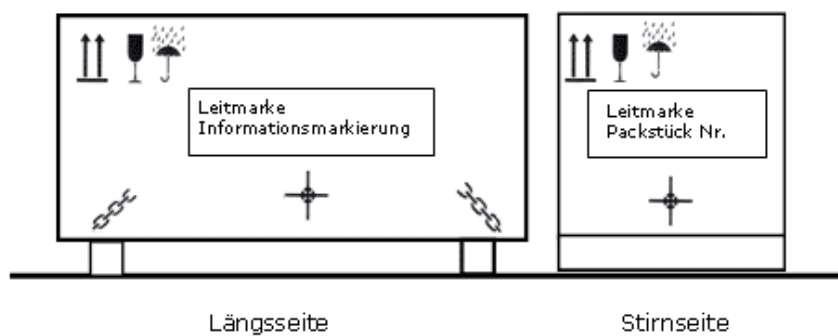

Figure 10: Schematic representation of a package marking



Figure 11: Examples of a box, which is provided with a leading mark, information and handling mark.

Information regarding other handling symbols can be viewed in Annexe 1.

12.2.4 Delivery note specifications

- Delivery note number (if possible, also as a barcode)
- Delivery date (if possible, also as a barcode)
- Supplier address (name, ZIP, place, country)
- Order number and order item
- AVL – material number / designation as per order
- Quantity and unit of quantity

12.2.5 Material sets

If material sets are ordered (AVL – material number consists of multiple individual parts), packaging must be done set-wise. The exact definition is evident in the respective order.

12.2.6 Packing lists

If an order or a delivery consists of multiple packages, a packing list must be fixed on **every package**.

Minimum specifications on the packing list:

- Order number and order item
- AVL – material number as per order
- Quantity and unit of quantity
- Delivery date

12.2.7 Hazardous goods

The packaging of hazardous goods must comply with the legal regulations of the respective country and the means of conveyance. Hazardous goods must always be packed separately from the rest of the shipment

The most important international regulations are:

- European Agreement concerning the International Carriage of Dangerous Goods by Road (ADR) for the road traffic for many European and neighbouring countries,
- Regulations on the International Carriage by Rail of Dangerous Goods (RID) in rail traffic,
- European Agreement concerning the International Carriage of Dangerous Goods by Inland Waterways (ADN) for the inland water transport,
- International Maritime Dangerous Goods Code (IMDG-Code) in the international maritime traffic,
- Technical Instructions for the Safe Transport of Dangerous Goods by Air (ICAO-TI) in air traffic, published by the International Civil Aviation Organization: ICAO). They are accepted by the International Association of the air transport companies of the

PACKAGING AND MARKING GUIDELINE

International Air-Transport Association (IATA) with the IATA Dangerous Goods Regulations (IATA-DGR).

They are applicable according to the provisions of the law for the transportation of dangerous goods, also for purely domestic transports.

13 Indicators

Indicators are used for monitoring the logistical processes of transport, trans-shipment and storage. The traceability must be ensured using the serial number. For example, indicator serial numbers on the delivery note.

- **Tilt indicators**

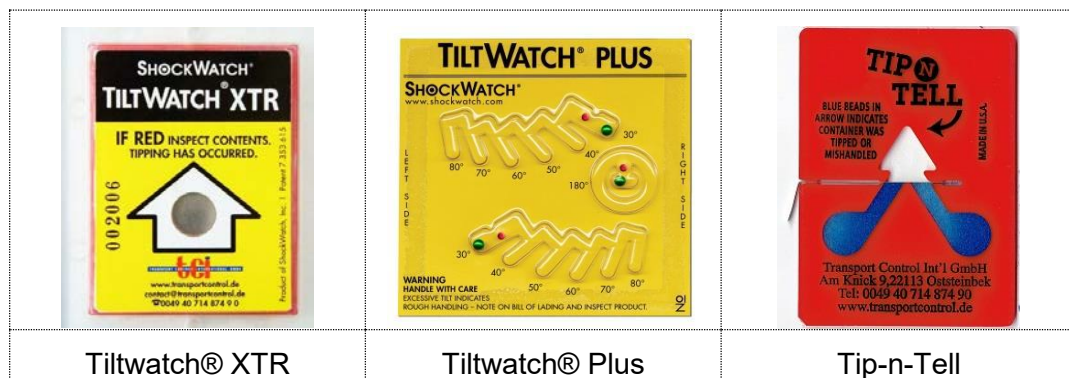

Figure 12: Examples of tilt indicators

- **Impact and shock indicators**



Figure 14 Examples of shock indicators

13.1 Tilt indicator

A tilt indicator is necessary if one of the following conditions exists:

1. $c_{x,y} \cdot d \geq c_z \cdot b$
2. from a package height of 160 cm

- $c_{x,y}$... horizontal acceleration coefficient of the respective mode of transport (chapter 10),
- d ... vertical distance from the core area of the loading unit up to its tilting axis [m],
- c_z ... vertical acceleration coefficient of the respective mode of transport (chapter 10),
- b ... horizontal distance from the core area of the loading unit up to its tilting axis [m].

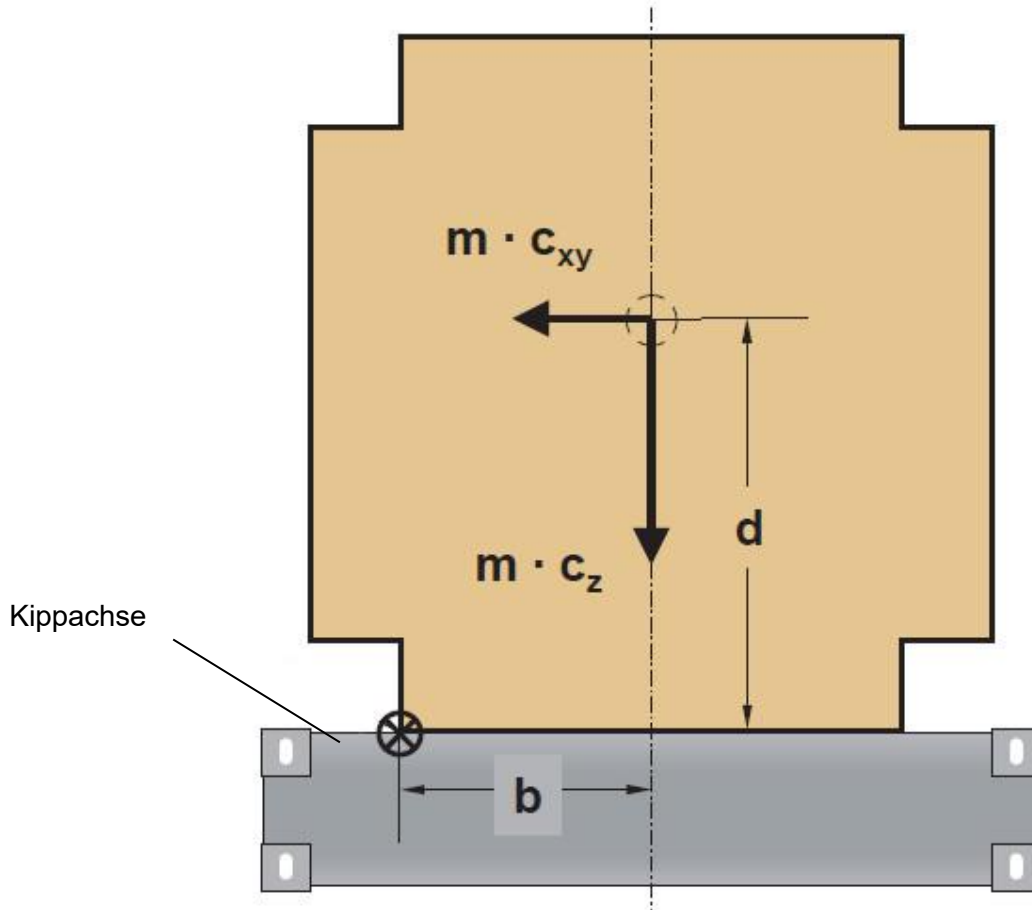

Figure 13: Criterion for attaching a tilt indicator

“The freight is tilt-safe if the height of the core area is less than half the width of its base.”

13.2 Impact indicators

All the packages with sensitive and/or electrical components must be equipped with impact indicators. In order that the ShockWatch® indicators do not trigger too early or too late, it is important to select the correct indicator for monitoring the package. The starting point for selecting the correct Shock-Watch® label is the size of the package in cubic meters (L x W x H) as well as the total weight including packaging.

Shockwatch® table:

PACKAGING AND MARKING GUIDELINE

Volumen Gewicht	0,001–0,030 cbm	0,031–0,135 cbm	0,136–0,400 cbm	0,401–1,350 cbm	1,351+ cbm
	0 – 5 kg				
6 – 12 kg					
13 – 23 kg					
24 – 45 kg					
46 – 112 kg					
113 – 450 kg					
451 – 650 kg					
651 – 750 kg					
751 – 1000 kg					

Figure 14: Selection table for Shockwatch®

Farbe	BLAU	GRAU	GELB	VIOLETT	ROT	ORANGE	GRÜN
Empfindlichkeit	10 g / 50 ms	15 g / 50 ms	25 g / 50 ms	37 g / 50 ms	50 g / 50 ms	75 g / 50 ms	100 g / 50 ms

Figure 15: Allocation of the colours to the g-values Shockwatch®

Shockwatch® 2 table

Volumen Gewicht	0,14–0,42 cbm	0,42–1,42 cbm	1,42–2,83 cbm	2,83–7,08 cbm	7,08–14,16 cbm	14,16–304,08 cbm	304,08+ cbm
	0 – 5 kg					N/A	N/A
5 – 11 kg						N/A	N/A
11 – 23 kg							N/A
23 – 45 kg							
45 – 113 kg							
113 – 454 kg							
454 – 907 kg							
907 – 2268 kg							
2268 – 4536 kg							
4536 – 6804 kg	N/A						
6804 – 9072 kg	N/A	N/A					
9072 – 13608 kg	N/A	N/A	N/A				
13608+ kg	N/A	N/A	N/A	N/A			

Figure 16: Selection table for Shockwatch® 2

Farbe	PINK	TÜRKIS	BLAU	GELB	VIOLETT	ROT	ORANGE
Empfindlichkeit	5 g / 50 ms	10 g / 50 ms	15 g / 50 ms	25 g / 50 ms	37 g / 50 ms	50 g / 50 ms	75 g / 50 ms

Figure 17: Allocation of the colours to the g-values Shockwatch® 2

14 IPPC/ ISPM no. 15

14.1 IPPC-STANDARD (International Plant Protection Convention)

ISPM 15 is applicable only to solid wood. This excludes wood-based materials and solid wood thinner than 6 mm. Handling the packaging as per the accepted measures.

14.1.1 IPPC marking

The marking must be attached permanently and such that it is properly legible and visible, on at least **two opposite** sides of the packaging. The colour must be seawater-proof and light-resistant. “RED” and “ORANGE” are impermissible colours.

- IPPC symbol
- Country code as per ISO 3166
- Code for the region
- Registration number
- Treatment method HT (heat treatment) or MB (methyl bromide)

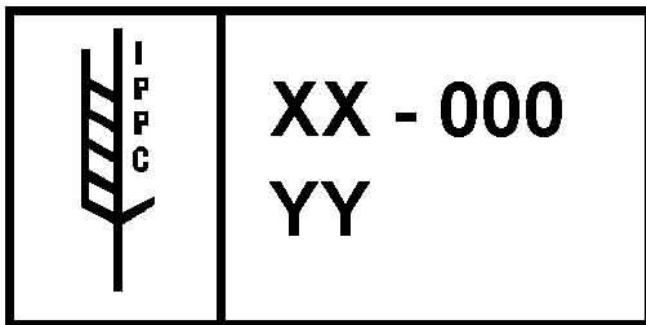

Figure 18: Example of a labelling as per ISPM 15

The import regulations applicable to packaging/ packaging materials must be taken from the “International Standard for Phytosanitary Measures No. 15 available on <http://www.ispm15.com/start.htm>.

15 Cost assumption

In case of non-adherence of the specifications stipulated in these regulations, AVL List GmbH reserves the right to refuse the acceptance of the shipment and/or to charge the resulting additional costs (e.g. storage, repacking, disposal, increased search expenses owing to lack of order or material data).

16 Transport damages

If we received a damaged packaging that indicates possible damages to the goods, we will not accept this delivery and return it at the expense of the supplier.







17 Goods acceptance times

Monday to Thursday: 08:00-12:00 / 13:00-15:00

Friday : 08:00-12:00 / 13:00-14:00









18 Annex

Handling marks:

No.	Meaning	Symbol	Function	Remark
1.	Fragile		The content of the package is fragile, and it must therefore be handled with care.	ISO 7000, no. 0621 Application example:
2.	Do not use hooks		Hooks are prohibited for handling this package.	ISO 7000, no. 0622
3.	Top		Indicates the correct perpendicular position of the package.	ISO 7000, no. 0623 Application example:
4.	Protect from heat		The package must be protected from heat.	ISO 7000, no. 0624
5.	Protect from moisture		The package must be stored in a dry environment.	ISO 7000, no. 0626
6.	Core area		Indicates the core area of the package, which is handled as an individual unit.	ISO 7000, no. 0627 Application example:
7.	Do not roll		The package must not be rolled.	ISO 7000, no. 2405

PACKAGING AND MARKING GUIDELINE

Handling marks (continued)

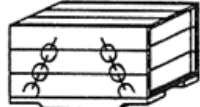
No.	Meaning	Symbole	Function	Remark
8.	Do not position a hand truck there		Hand trucks must not be positioned on this side for handling the package.	ISO 7000, no. 0629
9.	Do not position a forklift truck		The package should not be handled with forklift trucks.	ISO 7000, no. 2406
10.	Clamps in direction of arrow		The clamps must be positioned at the indicated sides for handling the package.	ISO 7000, no. 0631
11.	Do not position clamps in the direction of arrow		The package should not be handled with clamps at the indicated sides.	ISO 7000, no. 2404
12.	Limiting the mass of the stack load		Indicates the limitation of the mass of the stack load of packages.	ISO 7000, no. 0630
13.	Stack limitation		Maximum number of identical packages, which may be stacked, where n stands for the number of permissible packages.	ISO 7000, no. 2403
14.	Do not stack		The packages must not be stacked, and no load should be placed on the package.	ISO 7000, no. 2402
15.	Attach here		Lifting accessories must be placed as shown for lifting the package.	ISO 7000, no. 0625 Application example: 

PACKAGING AND MARKING GUIDELINE

Handling marks (continued)







No.	Meaning	Symbole	Function	Remark
16.	Permissible temperature range		Indicates the temperature range in which the package must be stored and handled.	ISO 7000, no. 0632 Application example:  a)  b)
17.	Do not damage barrier layer		A steam-proof barrier layer is located below the outer packaging, in which the drying agents for corrosion protection are placed. This protective effect will lapse if the barrier layer is damaged. As the symbol has still not been accepted by ISO, a puncturing of the outer cover must be avoided especially in case of packages having the "Packed with desiccants" imprint.	
18.	Tear open here		This symbol is intended only for the recipient.	
19.	Load only in the topmost position or: top storage or: do not overstay			

Table 7: Standardised handling codes

19 Applicable documents

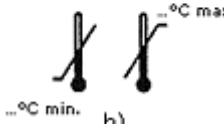
- QM4200GD01: Guideline to foreign trade control
 QM8500VA02: Outgoing Goods Packaging Directive